

INSTALLATION, OPERATION AND MAINTENANCE INSTRUCTIONS

BMI PUMPS



"ISO 9001:2015 Quality
Management System"



Pumping Solutions

Mr. Proprietor

Congratulations! You have just purchased an equipment of simple construction, designed with the most advanced technology, with excellent performance and that allows easy maintenance.

The goal of this Manual is to inform the user about the details of the equipment and the correct techniques for Installation, Operation and Maintenance.

IMBIL recommends that the equipment is installed and cared for according to what is recommended by the best practices and according to the instructions included in this Manual, and used according to the service conditions to which it has been selected (flow, total developed head, speed, voltage, frequency and temperature).

IMBIL cannot be held responsible for faults caused by the inobservance of the service prescriptions and recommends that this Manual is used by the personnel responsible for installation, operation and maintenance.

 Pumping Solutions	
Model:	<input type="text"/>
Serial number:	<input type="text"/>
TAG:	<input type="text"/>
IMPELLER [Ø]:	<input type="text"/>
ROTATION:	<input type="text"/>
DIRECTION:	<input type="text"/>
FLOW [Q]:	<input type="text"/>
THD/HEAD:	<input type="text"/>
DATE:	<input type="text"/>
<small>IMBIL IND. E MAN DE BOMBAS ITA LTDA - www.imbil.com.br RUA JACOB AUDI, 690 ITAPIRA Indústria Brasileira CNPJ.: 51.4826776/0001-28 - FONE(19) 3843-3633</small>	

In case of consultation about the equipment or when ordering spare parts, indicate the part code, model, pump line and also the serial number found on the identification plate and engraved on the suction flange.

NOTE: IMBIL requests that the customer fills out all the data right after receiving the WARRANTY TERM of his/her equipment and sends the stub to IMBIL, making the exchange of information between IMBIL and the CUSTOMER easier.

INDEX

INSPECTION UPON RECEIPT.....	03
TRANSPORT.....	03
STORAGE.....	04
LOCATION.....	04
FOUNDATION.....	04
BASEPLATE LEVELING AND FIXING	05
COUPLING ALIGNMENT.....	06
GENERAL RECOMMENDATIONS FOR PIPINGS	06
Suction piping only.....	07
Pumping piping only	08
GETTING READY FOR OPERATION	10
Rotation direction.....	10
Impeller clearance.....	10
Bearing lubrication.....	11
Sealing liquid.....	11
General steps before start up	11
Immediate steps after the beginning of operation.....	12
Steps for the pump stoppage.....	12
MAINTENANCE.....	12
Maintenance planning.....	12
Bearing housing maintenance.....	14
Packing maintenance	15
Adjustment of the impeller clearance.....	17
Rolling bearings and retainers.....	19
CROSS-SECTIONAL DRAWING AND PARTS LIST	20
INTERCHANGEABILITY BETWEEN PUMPS	22
TROUBLESHOOTING	23
RECOMMENDED SPARE PARTS	24

INTRODUCTION

Inspect the equipment as soon as you receive it and check it against the invoice, immediately reporting parts that may be missing or damaged. Make sure no damage has occurred during transport and in case it did happen report the incident as soon as possible to IMBIL.

TRANSPORT

The transport of the coupled set or separate equipments must be done with care and according to the safety standards.

Before coupling the engine to the pump motor they must be transported through the lifting eye or by chains or belts tied underneath the suction flange and bearing, as shown in the figure below:



The pump-motor train must be transported as shown below:

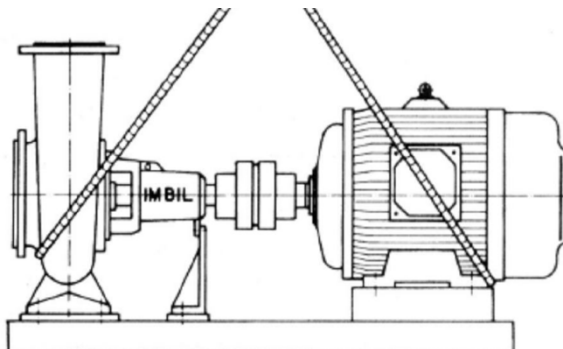

STORAGE

When it is necessary to store a pump until it can be installed, the protective flanges of the nozzles or any other protection sent by Imbil should not be removed.

The bearings receive lubrication at the factory which protects them from oxidation for a short time.

In pumps stored for more than 30 days, special precautions will be required:

- Remove the packings to avoid corrosion of the bushings.
- Sprinkle oil on the bearing housing and pump every 30 days.
- Manually rotate the shaft weekly so that all the mobile parts can be lubricated.

NOTE: Before pump installation clean the protections of the shaft end, sleeve and flanges with the appropriate solvent and follow the instructions of this Manual.

LOCATION

Choose the installation site so that it meets the following requirements:

It is easily accessible to inspection and maintenance.

It is above flooding level.

There is enough space to remove the engine.

The foundation is stable so that it does not move horizontally and/or vertically, allowing the pump to be supported by the piping.

The identification plates of the pump and engine are visible.

There is enough air circulation around the engine to assure perfect refrigeration.

FOUNDATION

The pump should preferably be installed in a horizontal position. Use a single baseplate for the pump and engine on a permanent foundation of concrete or structural steel with enough mortar to absorb all normal vibrations, preventing the equipment from suffering distortions or having the alignment compromised.

BASE LEVELING AND FIXING

Put the anchor bolts in the holes made in the foundation block under the holes of the base.

Introduce specific mortar around the anchor bolt and under the baseplate through the existing holes for a solid fixation and a vibration free operation.

Tighten the anchor bolt nuts after the mortar cure, checking the transversal and longitudinal leveling with high precision. If it is unlevelled, add fine plates between the baseplate and the Chock for correction.

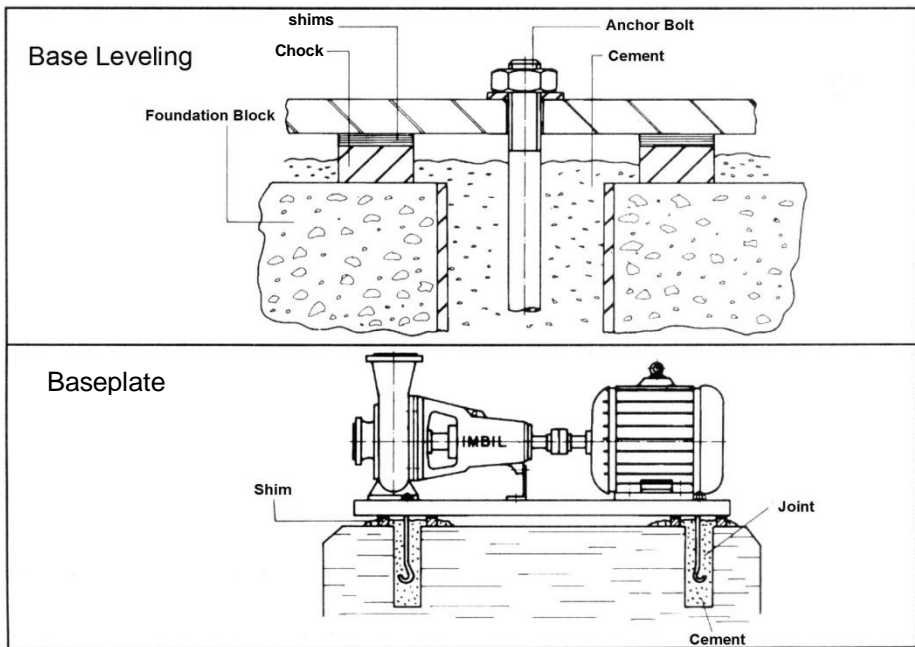

COUPLING ALIGNMENT

Carry out the alignment with the suction and discharge piping already connected.

With the aid of a dial indicator or, in its absence, a metallic ruler and feeler gauge, remove axial and radial misalignment to avoid vibrations during life cycle of the equipment.

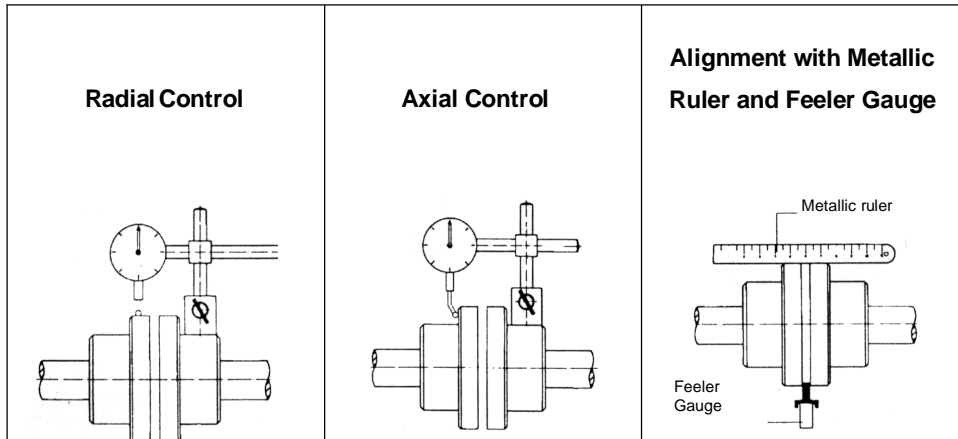

If there is a belt drive, the shafts of the pump and driver must be parallel, the pulleys aligned between one another, and the belts correctly stretched.

Alignments: The radial and axial misalignments must be within a tolerance of 0.3 mm, complying with the clearance between the engine and pump shaft necks, as specified by the coupling manufacturer.

For increased safety during operation, a Coupling guard or an Actuation protector, according to Law 65/4 Decree MTb 3214 (NR 12 item 12.3).

GENERAL RECOMMENDATIONS FOR PIPINGS

For suction and discharge piping

The piping must be connected to the pump flange only after the curing of the mortar for baseplate fixing.

To avoid pressure losses, the piping must be as short and straight as possible, and the curves, wherever necessary, must have long radius.

The pump cannot work as a support for the piping. The piping flanges must be connected to pump flanges, totally free from stresses, so as to not transmit forces to the pump casing, and avoiding misalignment and its consequences.

When the pumped liquid is subject to extended temperature variations, expansion gaskets must be provided.

Suction piping only

If there is a positive suction head, the horizontal segment of the suction piping should be installed with a slight inclination towards the suction tank. In case of a negative suction head, there should be a slightly negative slope in the direction of the suction reservoir, avoiding the formation of air pockets. See pictures on page 9.

The nominal diameter of the pump's suction flange does not determine the suction piping nominal diameter. The speed of the liquid flow should be between 1 and 2 m/s. When a reduction is necessary, it should be eccentric, positioned with the cone in downward position, thus avoiding the formation of air pockets. See pictures on page 10.

When a foot valve is applicable, generally a filter is required in order to prevent foreign bodies from entering the pump. Ensure that the valve passage area is 1.5 times larger than the area of the pipe and the free passage area of the filter is 3 to 4 times larger than the area of the piping.

In installations with a positive suction head, it is advisable to install a valve to block the liquid passage. Ensure that during pump operation the valve remains fully open.

It is advisable to avoid assembling more than one pump in a single suction line, especially when the absolute pressure in this pipe is less than the atmospheric pressure during pump operation.

A valve should be provided for each pump in installations where several pumps have the same suction reservoir and there should be a connection between the tank and the suction line by piping with eventual bends with angles smaller than 45 degrees.

Discharge piping only

It is necessary to install a discharge valve for flow and pressure regulation right after the pump's discharge flange.

When the length of the discharge piping is relatively large and pump's total elevation head is greater than 15 meters, it is recommended to install a check valve between the pump outlet and the discharge valve.

When the piping diameter is different from the diameter of discharge flange, a connection must be made through a concentric reduction.

Provide relief valves whenever there is a need to purge the air.

For pumps installed in a parallel position, each pump should have its own check valve in order to prevent back flows or overloading the foot valve, when one of the pumps is turned off.

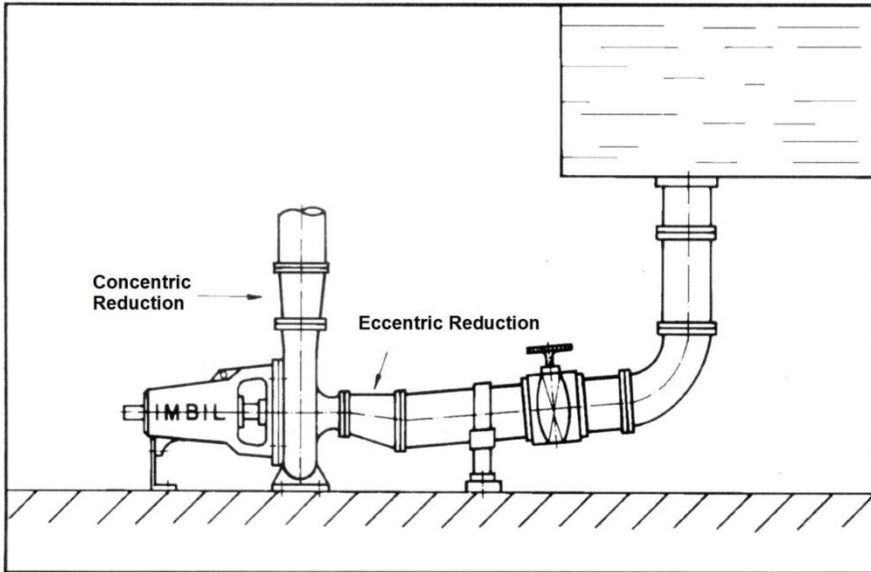
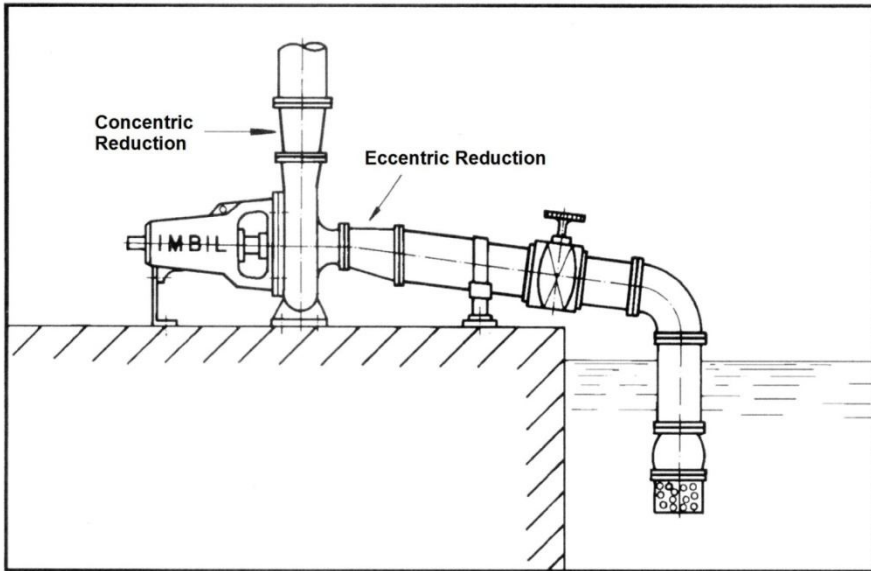

GETTING READY FOR OPERATION

If the equipment is installed in an environment with explosion potential make sure that the engine is explosion proof.

Rotation direction:

Check if the rotation direction is correct: Serious accidents can happen if the pump is started with the wrong rotation direction.

1. Remove the engine from the power source.
2. Uncouple the engine shaft from the pump shaft.
3. Separate those two shafts.
4. Turn the engine on and check if its rotation direction is in accordance to the rotation direction indicated on the pump bearing housing.
5. Remove the engine from the power source and align the pump-motor shafts.

Impeller clearance:

The procedure for the adjustment of the impeller clearance must be rigorously followed. An inadequate clearance adjustment may result in spark, heat generation and damage the equipment.

Before operating the pump, the impeller clearance must be checked. This check will help to guarantee that the pump will operate freely and with an optimum efficiency, contributing to a longer life cycle and lower energy consumption.

Hereafter we present the recommended clearance between the impeller and plate in relation to the operational temperature. Any value above the recommended levels will result in a significant performance loss.

MODEL	CLEARANCE [mm]		MODEL	CLEARANCE [mm]	
	UP TO 93°C	FROM 93°C TO 121° C		UP TO 93°C	FROM 93°C TO 121° C
BMI 25-200	0.13	0.16	BMI 50-330	0.20	0.23
BMI 40-200	0.13	0.16	BMI 80-330	0.20	0.23
BMI 50-200	0.20	0.23	BMI 100-330	0.20	0.23
BMI 80-200	0.20	0.23	BMI 150-330	0.38	0.41
BMI 80-200G	0.20	0.23	BMI 200-330	0.38	0.41
BMI 25-250	0.20	0.23	BMI 200-380	0.38	0.41
BMI 50-250	0.20	0.23	BMI 200-380G	0.38	0.41
BMI 80-250	0.20	0.23	BMI 250-330	0.38	0.41
BMI 100-250	0.20	0.23			

Bearing lubrication:

The bearings must be lubricated correctly to assure that there is no generation of excessive heat that would result in a reduced bearing life.

ATTENTION: The pumps are supplied without oil in the bearing housing.

Fill the bearing with oil through the plug located at the top part, until the oil level reaches the center of the level display. Use the oil recommended in the chapter: Bearing Housing Maintenance.

Sealing liquid:

If the pressure in the stuffing box is superior to the atmospheric pressure and the pumped liquid is clean, a leakage flow of 40-60 drops per minute is generally enough to lubricate and cool the packing rings and a sealing liquid from an external source is not necessary.

A sealing liquid from an external source is necessary when:

- Abrasive particles in the pumped liquid can damage and quickly erode the shaft's protector sleeve.
- The pressure in the sealing box is lower than the atmospheric pressure.

Therefore, whenever is necessary to have a sealing liquid from an external source, make sure that:

- the liquid is clean and compatible with the pumped fluid.
- the pressure is be 1 kg/cm² above suction pressure. The piping must be connected to the stuffing box connection; recommended dripping is about 40-60 drops per minute.

General arrangements before start up:

Make sure the pump-motor train is aligned and well fixed on the baseplate, and that the suction and discharge flanges are well connected to the piping.

Prime (fill up) the pump and suction piping, eliminating the air. Manually turn the pump shaft to assure good priming. If necessary, priming can be done by using vacuum pump.

Whenever there is a suction valve it must be maintained totally open. The suction valve should never be used to regulate the pump flow, in order to avoid the possibility of cavitation. It must be used only for isolating the pump during maintenance.

The discharge piping must be closed at start-up to avoid overloading the engine and the power supply..

After reaching normal speed in a few seconds, slowly open the discharge valve so as to regulate the pump capacity.

Immediate steps after the beginning of operation:

Make sure the equipment operates without vibrations and abnormal noise. Control the values of the net voltage and the current of the electric motor.

Control the bearing temperature; it shall not exceed 82°C.

Adjust the packing by tightening the nuts of the gland in a uniform way, regulating the dripping velocity.

Check the suction and discharge pressure and the flow rate.

Control the above items every 30 minutes during the first operating hours, every hour during the next 10 hours operation and then weekly.

Steps for the pump stoppage:

Close the discharge valve.

Close the suction valve when is necessary to carry out maintenance services.

Turn off the driver observing a gradual stop of the equipment.

Close the auxiliary piping if present.

MAINTENANCE

NOTE: A routine maintenance program significantly increases the durability of the pump. Carrying out maintenance in an appropriate way will assure that the equipment will operate without failures for a longer time and will require less spare parts.

Maintenance planning:

Next we present a few procedures that will help increase the life cycle of the equipment.

ROUTINE MAINTENANCE:

- Bearing lubrication
- Sealing monitoring
- Vibration analysis
- Discharge pressure monitoring
- Temperature monitoring

ROUTINE INSPECTIONS:

Check the level and conditions of the lubricant oil through the acrylic display installed in the bearing.

Check for abnormal noise, vibrations and bearing temperature.

Inspect the pump and piping to assure there are no leaking spots.

Check the stuffing box/packing rings or mechanic seal:

Mechanic seal: there should no leakage;

Packing gland: if there is excessive leakage, tighten the nuts of the gland and if necessary replace the packing rings.

INSPECTIONS DURING THE FIRST THREE MONTHS OF OPERATION:

Check the foundation and if the screws are tight in it.

If the pump has been idle, check the gaskets and replace them if necessary.

The bearing lubricant oil must be changed at least every three months (2000 hours) or more frequently if there is any critical condition in the working atmosphere of the equipment, which can contaminate the lubricant easier. If it is noticeable through the acrylic display the oil has a different color and there are contaminants it must be immediately replaced.

Check the shaft alignment and realign it if necessary.

ANNUAL INSPECTIONS:

Check the flow, pressure and power consumed by the pump. If the pump performance no longer meets the requirements of the process and the system has not been altered, the pump must be disassembled, inspected and the worn out parts must be replaced. If the problem persists an inspection of the entire installation must be carried out.

Bearing housing maintenance:

LUBRICANT OIL:

ATTENTION: The pumps are supplied without oil in the bearing housing. At operating site, the bearing housing must be filled with oil to the correct level.

Remove the plug located at the top of the bearing housing and add oil until the level reaches the center of the acrylic display. After completing, put the plug back into the bearing housing.

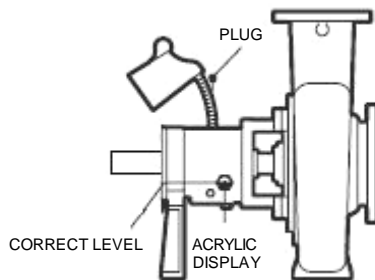

The first bearing oil change should be done after the first 200 hours of equipment operation. Afterwards, the lubricant oil changes must happen after every 2000 hours of operation or every 3 months (whichever happens first).

It is also recommended to disassemble and wash the bearing every 2 years.

Next we present the approximate amount of lubricant that must be used for each model:

MODEL	AMOUNT [ml]	MODEL	AMOUNT [ml]
BMI 25-200	400	BMI 50-330	1250
BMI 40-200	400	BMI 80-330	1250
BMI 50-200	1250	BMI 100-330	1250
BMI 80-200	1250	BMI 150-330	3000
BMI 80-200G	1250	BMI 200-330	3000
BMI 25-250	1250	BMI 200-380	3000
BMI 50-250	1250	BMI 200-380G	3000
BMI 80-250	1250	BMI 250-330	3000
BMI 100-250	1250		

RECOMMENDED OILS

MANUFACTURER	UP TO 3000 rpm	ABOVE 3000 rpm
Castrol	Hyspin – 68	Hyspin – 46
Atlantic	Eureka – 68	Eureka – 46
Esso	Turbine oil – 68	Turbine oil – 46
Mobil Oil	DTE – 26	DTE – 24
Ipiranga	IPTUR AW – 68	IPTUR AW – 46
Petrobrás	Marbrax TR – 68	Marbrax TR – 46
Shell	Tellus – 68	Tellus – 46
Texaco	Regal R & O - 68	Regal R & O - 46

Packing maintenance:

If the packing gland has already been tightened more than 8 mm and still there is excessive leakage, change the packings in the following way:

Loosen the nuts from the packing gland, which is split, push the halves to the side of the base cover and remove the packing gland.

Carefully remove the packings with the aid of a flexible rod, clean the stuffing box, removing eventual residues.

Check the surface of the protector sleeve, which must be smooth, without burrs or marks that might damage the packings. In case the protector sleeve has marks, it can be re-machined at its external diameter with a maximum material removal of 1 mm, or it must be substituted.

The packings are normally supplied as continuous straps, which must be sectioned into rings with oblique extremities with the appropriate size in relation to the shaft sleeve diameter, and mounted as instructed below.

Oblique Cut of the Packing

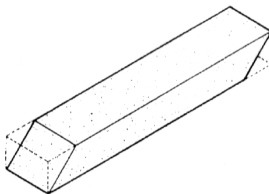

To cut the packing rings, it is advisable to use a simple device as illustrated below:

Device to cut the packing
rings

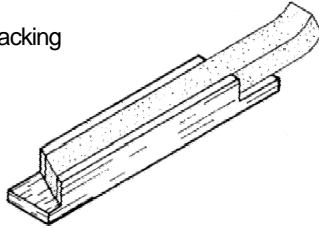

After cutting the first ring, assure that its size is correct for a perfect adjustment in the stuffing box.

Spread a thin grease coating in the external and internal diameters of the packing rings, and assemble one at a time in the following order:

- Two packing rings
- A lantern ring
- Remaining packing rings

Move the second ring seam about 120 degrees in relation to the first ring, and so on, until placing the last packing ring, as shown in the picture below:

Position of the rings
staggered by 120°

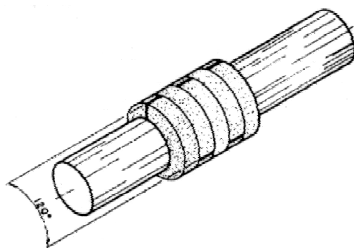

Check if the shaft can rotate after assembling each ring. Position the packing gland pressing the last ring, and manually tighten the nuts. Turn the shaft to assure that it does not touch the packing gland.

Adjustment of the impeller clearance:

A change in pump performance may be noticed whenever there is a pressure or flow decrease or an increased power consumption. The pump performance can be improved by adjustment of the impeller clearance. Next we will explain the procedure to adjust the impeller clearance:

Remove coupling guard and uncouple the pump.

Mount a dial indicator fixed in a base with the rod on the shaft end as shown in the picture.

Loosen the nuts of the adjusting screws. Drive the screws back approximately two turns.

Tighten every lock screw conducting the bearing housing cover towards the bearing housing until the impeller touches the casing. Turn the shaft to assure that the impeller touches the casing.

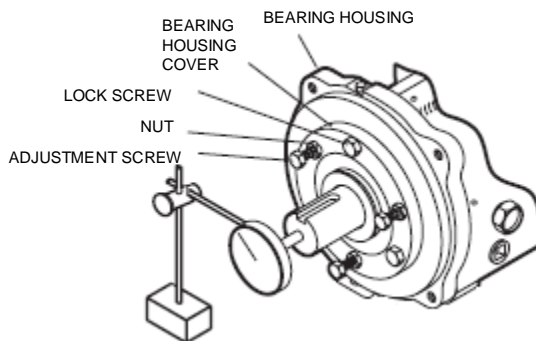

Zero the dial indicator and loosen the lock screws approximately one turn.

Tighten the adjustment screws until they touch the bearing housing.

Now tighten the adjustment screws making the bearing housing cover move away from the bearing housing until the dial indicator shows the appropriate clearance recommended in this Manual.

After reaching the correct clearance tighten the nuts.

Tighten the lock screws maintaining the clearance shown in the dial indicator.

Check if the shaft can rotate freely.

Couple the pump again.

Rolling bearings and retainers:

In the following table we present the commercial codes and basic dimensions for the bearings and retainers used in the BMI pumps.

MODEL	Back bearing	Dimensions [mm]	Front bearing	Dimensions [mm]	Back Lip Seal	Dimensions [mm]	Front Lip Seal	Dimensions [mm]
BMI 25-200	3306C3	Ø30xØ72x30.2	6207C3	Ø35xØ72x17	01554BRG	Ø22xØ32x7	01366BRLI	Ø35xØ72x10
BMI 40-200	3306C3	Ø30xØ72x30.2	6207C3	Ø35xØ72x17	01554BRG	Ø22xØ32x7	01366BRLI	Ø35xØ72x10
BMI 50-200	3309C3	Ø45xØ100x39.7	6309C3	Ø45xØ100x25	02038BRG	Ø39.4xØ63.55x12.7	00276BR	Ø45xØ72x9.5
BMI 80-200	3309C3	Ø45xØ100x39.7	6309C3	Ø45xØ100x25	02038BRG	Ø39.4xØ63.55x12.7	00276BR	Ø45xØ72x9.5
BMI 80-	3309C3	Ø45xØ100x39.7	6309C3	Ø45xØ100x25	02038BRG	Ø39.4xØ63.55x12.7	00276BR	Ø45xØ72x9.5
BMI 25-250	3309C3	Ø45xØ100x39.7	6309C3	Ø45xØ100x25	02038BRG	Ø39.4xØ63.55x12.7	00276BR	Ø45xØ72x9.5
BMI 50-250	3309C3	Ø45xØ100x39.7	6309C3	Ø45xØ100x25	02038BRG	Ø39.4xØ63.55x12.7	00276BR	Ø45xØ72x9.5
BMI 80-250	3309C3	Ø45xØ100x39.7	6309C3	Ø45xØ100x25	02038BRG	Ø39.4xØ63.55x12.7	00276BR	Ø45xØ72x9.5
BMI 100-	3309C3	Ø45xØ100x39.7	6309C3	Ø45xØ100x25	02038BRG	Ø39.4xØ63.55x12.7	00276BR	Ø45xØ72x9.5
BMI 50-330	3309C3	Ø45xØ100x39.7	6309C3	Ø45xØ100x25	02038BRG	Ø39.4xØ63.55x12.7	00276BR	Ø45xØ72x9.5
BMI 80-330	3309C3	Ø45xØ100x39.7	6309C3	Ø45xØ100x25	02038BRG	Ø39.4xØ63.55x12.7	00276BR	Ø45xØ72x9.5
BMI 100-	3309C3	Ø45xØ100x39.7	6309C3	Ø45xØ100x25	02038BRG	Ø39.4xØ63.55x12.7	00276BR	Ø45xØ72x9.5
BMI 150-	3313W AC3	Ø65xØ140x58.7	6313UC3	Ø65xØ140x33	02116BAH	Ø60.3xØ82.5x11	01790BL	Ø63.5xØ82.5x12.7
BMI 200-	3313W AC3	Ø65xØ140x58.7	6313UC3	Ø65xØ140x33	02116BAH	Ø60.3xØ82.5x11	01790BL	Ø63.5xØ82.5x12.7
BMI 200-	3313W AC3	Ø65xØ140x58.7	6313UC3	Ø65xØ140x33	02116BAH	Ø60.3xØ82.5x11	01790BL	Ø63.5xØ82.5x12.7
BMI 200-	3313W AC3	Ø65xØ140x58.7	6313UC3	Ø65xØ140x33	02116BAH	Ø60.3xØ82.5x11	01790BL	Ø63.5xØ82.5x12.7
BMI 250-	3313W AC3	Ø65xØ140x58.7	6313UC3	Ø65xØ140x33	02116BAH	Ø60.3xØ82.5x11	01790BL	Ø63.5xØ82.5x12.7



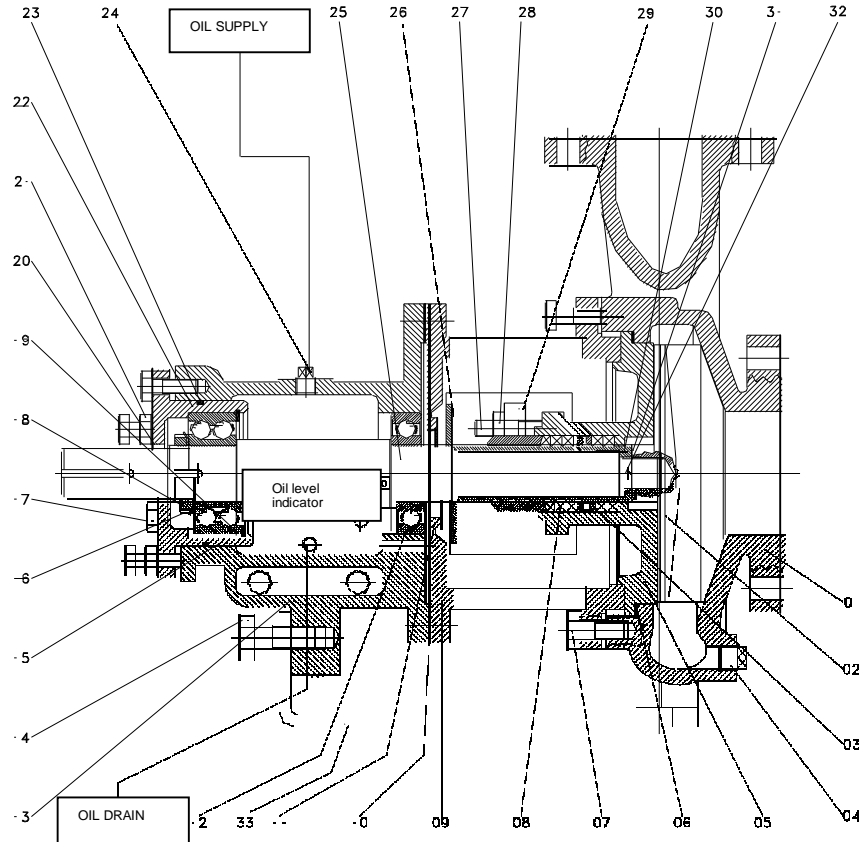

CROSS-SECTIONAL DRAWING AND PARTS LIST











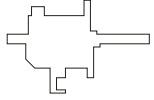

Parts identification:

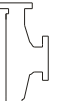
POSITION	PART DESCRIPTION
01	CASING
02	IMPELLER
03	LANTERN RING
04	PLUG
05	COVER
06	GASKET
07	BOLT
08	PACKING
09	LANTERN
10	GASKET
11	FRONT LIP SEAL
12	FRONT BEARING
13	BEARING HOUSING
14	BOLT
15	BEARING HOUSING COVER
16	LOCK WASHER
17	LOCK SCREW
18	LOCK NUT
19	RETAINING RING
20	BACK LIP SEAL
21	ADJUSTING NUT AND SCREW
22	BACK BEARING
23	O-RING
24	PLUG
25	SHAFT
26	FLINGER
27	STUFFING BOX STUD
28	STUFFING BOX NUT
29	GLAND
30	PROTECTOR SLEEVE
31	O-RING
32	LOCK PIN
33	SUPPORT FOOT

INTERCHANGEABILITY BETWEEN PUMPS

	<i>SHAFT AND BEARING HOUSING</i>	<i>ADAPTER RING</i>	<i>COVER</i>	<i>IMPELLER</i>	<i>CASING</i>
MODEL					
BMI 25-200	BMI 25-200	BMI 25-200	BMI 25-200	BMI 25-200	BMI 25-200
BMI 40-200				BMI 40-200	BMI 40-200

	<i>SHAFT AND BEARING HOUSING</i>	<i>LANTERN</i>	<i>COVER</i>	<i>IMPELLER</i>	<i>CASING</i>	
MODEL						
BMI 50-200	BMI 50-200	BMI 50-200	BMI 50-200	BMI 50-200	BMI 50-200	
BMI 80-200				BMI 80-200	BMI 80-200	
BMI 80-200G				BMI 80-200G	BMI 80-200G	
BMI 25-250		BMI 25-250	BMI 25-250	BMI 25-250	BMI 25-250	BMI 25-250
BMI 50-250					BMI 50-250	BMI 50-250
BMI 80-250					BMI 80-250	BMI 80-250
BMI 100-250					BMI 100-250	BMI 100-250
BMI 50-330		BMI 50-330	BMI 50-330	BMI 50-330	BMI 50-330	BMI 50-330
BMI 80-330					BMI 80-330	BMI 80-330
BMI 100-330					BMI 100-330	BMI 100-330

	<i>SHAFT AND BEARING HOUSING</i>	<i>LANTERN</i>	<i>PRESSURE COVER</i>	<i>IMPELLER</i>	<i>HOUSING</i>	
MODEL						
BMI 150-330	BMI 150-330	BMI 150-330	BMI 150-330	BMI 150-330	BMI 150-330	
BMI 200-330				BMI 200-330	BMI 200-330	
BMI 250-330				BMI 250-330	BMI 250-330	
BMI 200-380		BMI 200-380	BMI 200-380	BMI 200-380	BMI 200-380	BMI 200-380
BMI 200-380G					BMI 200-380G	BMI 200-380G

TROUBLESHOOTING

PROBLEM	PROBABLE CAUSE	SOLUTION
The pump doesn't pump	The pump was not primed	Stop the pump and check if the pump and suction line are filled with liquid
	Suction line obstructed	Remove the obstructions
	Impeller clogged with material other than the pumped liquid	Remove the impeller obstruction
	Wrong rotation direction	Change the rotation direction according to the arrow indicated on the bearing housing or pump casing
	Foot valve or suction piping insufficiently submersed	Consult the factory for appropriate submerging. Use vortex breakers in the tanks.
Insufficient Flow and Pressure	The suction height is excessive	Decrease the suction height
	Air leaking through the packings	Substitute the packings.
	Air leaking through the stuffing box	Substitute or readjust the packings/mechanic seal
	Impeller partially clogged	Clean the impeller
	Excessive clearance between the impeller and casing	Adjust the clearance between the impeller and the casing.
	Insufficient pressure at suction	Assure that the suction line and the suction valve are completely open and clean, free from obstructions
Pump stops pumping after the start up	Impeller worn out or broken	Check and replace the impeller if necessary
	The pump was not correctly primed	Prime the pump again
	Air bubbles or vapor in the suction line	Re-adjust the piping to eliminate the air bubbles
Heating of Rollers	Air leaking into the suction line	Eliminate the leaking
	Incorrect aligning	Realign the pump and driver
Pump with abnormal vibration or noise	Inadequate lubrication	Check if the lubricant used is the one recommended and if the level is correct
	Incorrect aligning	Realign the pump and driver
	Impeller partially obstructed causing unbalancing	Eliminate the impeller obstruction
	Impeller or shaft broken or dented	Replace if necessary
	Foundation is not rigid	Check the tightening of the fixation screws of the pump and driver
	Rolling bearings worn out	Replace
	Suction or discharge piping are not adequately fixed	Fix it appropriately according to the technical standards
Pump is cavitating	Locate and correct the cause of the cavitation in the system	
Excessive leaking through the sealing box	Gland is not adequately adjusted	Tighten the gland nuts
	Stuffing box incorrectly packed	Check the packing and readjust the packing rings
	Mechanic seal worn out	Substitute the worn out parts
	Overheating of mechanic seal	Check and correct the lubrication and refrigeration of seal
	Protector sleeves worn out	Rework or replace if necessary
Engine working with overcurrent	Pressure and flow above specified	Consult the factory. Install a flow regulation valve, decrease impeller Ø
	Liquid viscosity different from specified	Check the viscosity of the pumped liquid
	Packings too tight	Readjust the packings and replace it if necessary
	Friction on the rotating parts	Check if internal wear parts and clearances are adequate

RECOMMENDED SPARE PARTS

IMBIL recommends the following spare parts for a continuous operation period of 2 years:

- Impeller
- Shaft
- Protector sleeve
- 1 set of bearings
- Retention ring
- Lock washer
- Locknut
- 1 set of lip seals
- Packings
- Gasket set
- O-ring set
- Complete mechanic seal (if used).

WARRANTY CERTIFICATE

ORIGINAL

WARRANTY TERM

The present "Warranty Term" has as objective to guarantee to the user all equipment shipments and/or the materials produced by the manufacturer, under the following conditions:

This term is valid for 12 (twelve) months from the effective start-up date of the equipment or 18 (eighteen) months from the invoicing date to the original user, whichever happens first.

The equipments and materials are covered by this warranty in regards to the repair or substitution of parts by IMBIL factory or by the authorized IMBIL technical assistance service against materials or fabrication defects, as long as there is evidence of these defects and against invoice presentation, with the following restrictions:

- All the material / equipment made by IMBIL or substituted part removed against warranty will become property of the manufacturer.
- Any repair, modification or exchanges against warranty will not prorogate the original equipment or substituted part warranty term.
- The manufacturer cannot be held responsible for losses caused by the equipment stop (Loss or Damage to Property).

The warranty does not cover:

- Transportation of the defective materials from the facility where they are installed to the manufacturer plant / technical assistance service and the later return to the original customer facilities.
- Travel and hotel expenses from the manufacturer technician, which will be charged according to the current pricing at the time of the repair service, when this it is performed at the installation site.

This warranty loses effect if the problem happens due to the following cases:

- Operational conditions that differ from the indicated by the manufacturer.
- Normal wear caused by the use or by erosion, abrasion or corrosion.
- Incorrect use, lack of knowledge from the operator, improper use, inadequate transportation, movement or stocking, assembly or operation other than the recommended by the technical manual provided by the manufacturer.

The equipments, due to constant improvements, are subject to changes without previous notice. The warranty is effective only if this slip is sent to the manufacturer.

COSTUMER WARRANTY CONTROL

Name: _____ Invoice _____ Date _____ / _____ / _____
 Address: _____
 ZIP Code: _____ State: _____ City: _____ Country: _____



Pumping Solutions

Reseller – Stamp and Signature

TOLL FREE NUMBER – COSTUMER SERVICE CENTER (BRAZIL): 0800 14-8500

MANUFACTURER WARRANTY CONTROL

Serial No. _____ Invoice _____ Date _____ / _____ / _____
 Name: _____
 Address: _____
 Zip code _____ City _____ State: _____ Country: _____



Owner Signature

Reseller – Stamp and Signature

Please fill out this form, detach it and send it to the manufacturer.

CUSTOMER SATISFACTION SURVEY

Dear Customer,

The biggest concern of IMBIL Group is to offer the best Customer Service, Product, Associated Services and Technical Support. For us, it is very important to know your opinion about the IMBIL's Quality. In knowing so IMBIL Group will be able to continually improve its quality. You can contribute by filling out this Customer Satisfaction Survey.

IMBIL GROUP thanks for your help.

Customer: _____

Address: _____

City: _____ State: _____ Zip Code: _____

Contact: _____ Date: ____ / ____ / ____

Department: _____ Function: _____

Phone: (____) _____ - _____ E-mail: _____

BRAZIL	<input type="checkbox"/> North	<input type="checkbox"/> Africa	WORLDWIDE	Application:	<input type="checkbox"/> Sugar and Ethanol Industry	<input type="checkbox"/> Air Conditioning
	<input type="checkbox"/> Northeast	<input type="checkbox"/> Central America			<input type="checkbox"/> Distilleries	<input type="checkbox"/> Chemical / Petrochemical / Naval
	<input type="checkbox"/> South	<input type="checkbox"/> North America			<input type="checkbox"/> Mining / Steel Industry	<input type="checkbox"/> Food Industry / Textile
	<input type="checkbox"/> Southeast	<input type="checkbox"/> South America			<input type="checkbox"/> Sanitation	<input type="checkbox"/> Steam Generation / Cogeneration
	<input type="checkbox"/> West Central	<input type="checkbox"/> Asia			<input type="checkbox"/> Pulp and Paper	<input type="checkbox"/> Fire Fighting
	<input type="checkbox"/>	<input type="checkbox"/> Europe			<input type="checkbox"/> Irrigation	<input type="checkbox"/> Other _____
	<input type="checkbox"/> Oceania	<input type="checkbox"/> Valve				

Product purchased: (Please indicate product's description and/ or serial num) _____

Acquisition of product: IMBIL Authorized Distributor _____ Representative _____

	Completely Satisfied	Very Satisfied	Satisfied	Dissatisfied	Completely Dissatisfied
1. CUSTOMER SERVICES QUALITY					
* Facility for contact, agility and efficiency in providing the information requested.					
2. COMMERCIAL CONDITIONS					
* Meeting your expectations related to commercial conditions.					
3. DELIVERY TIME					
* Meeting your expectations related to delivery time.					
4. TECHNICAL INFORMATION					
* Meeting your expectations related to technical data provided with the product.					
5. DELIVERY QUALITY					
* Meeting your expectations related to product shipping conditions (packaging, visual aspects).					
6. OPERATION QUALITY					
* Meeting your expectations related to product and operation conditions promised.					
7. POST SALES					
* Efficiency on services performed					

Would you have any suggestion on how to increase customer satisfaction on IMBIL's Products / Service?

Phones for Contacts

PABX Phone: +55 (19) 3843-9833 - FAX Sales: +55 (19) 3863-0714

Sales Department: +55 (19) 3843-9809 E-mail: export@imbil.com.br Quality Engineering: +55 (19) 3843-9804 E-mail: iqualidade@imbil.com.br

Post Sales: +55 (19) 3843-9830 e-Mail: assistenciaticnica@imbil.com.br Product Engineering: +55 (19) 3843-9870 E-mail: ienge@imbil.com.br

Customer Service: +55 DDG 0800 - 148500



IMBIL – INDÚSTRIA E MANUTENÇÃO DE BOMBAS ITA LTDA.
Rua Jacob Audi, 690 - Vila Izaura - CEP 13971-045 - Itapira-SP
PABX: *(019) 3843.9833 - FAX: Depto. Vendas (019) 3863.0714
Atendimento ao Consumidor DDG 0800.148500
<http://www.imbil.com.br> E-mail: ivendas@imbil.com.br